

ENT ORAL

CATALOGUE



ENT-ORAL

01- Scissors.....	01-03
02- Needles	04
03- Forceps.....	05-07
04- Clamps.....	08-14
05- Tracheal Dilators / Hooks / Retractors.....	15-16
06- Retractors.....	17-19
07- Tonsil Dissectors.....	20
08- Adenotomes, Tonsil Snares and Wires.....	21-23
09- Mouth Gags.....	24-32
10- Tonsil Knives.....	33
11- Suction Tubes.....	34
12- Adenoid Currettes.....	35-37
13- Syringes.....	38
14- Laryngeal Mirrors	39
15- Amalgam Carriers	40

ENT-ORAL
Oral Scissors

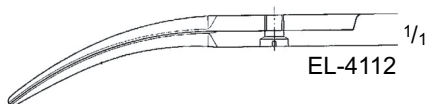
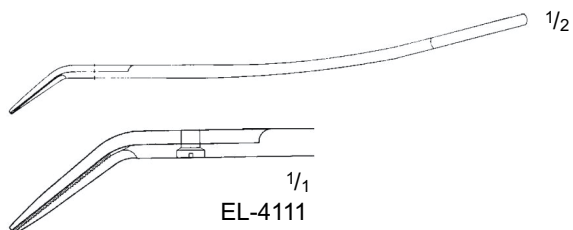
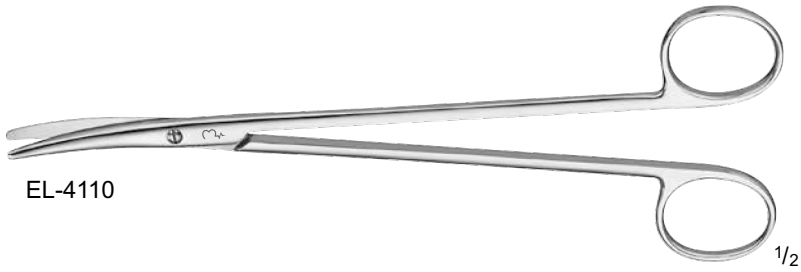
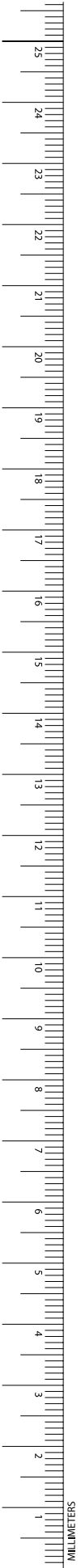

LILLIE Dissecting Scissors

Catalog Number	Tip	Blade	Length (in.)
EL-4110	B/B	CVD	7 7/8

DEAN Tonsil Scissors

Catalog Number	Tip	Blade	Length (in.)
EL-4111	B/B	ANG-SERR	6 3/4

BOETTCHER Tonsil Scissors

Catalog Number	Tip	Blade	Length (in.)
EL-4112	B/B	CVD	7

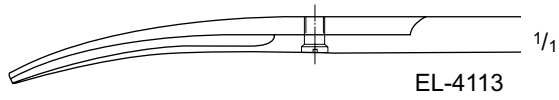

BROPHY Gum Scissors

Catalog Number	Tip	Blade	Length (in.)
EL-4113	S/S	CVD	5 1/2

Tungsten Carbide Scissors

- Excellent cutting accuracy
- Long working life
- Gold-plated rings

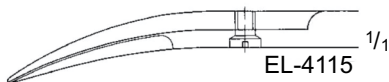
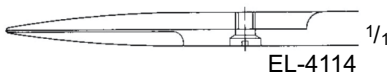
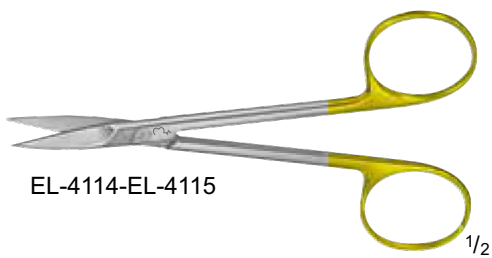

TC Gum Scissors, Delicate

Catalog Number	Tip	Blade	Length (in.)
EL-4114	S/S	STR	4 3/4
EL-4115	S/S	CVD	4 3/4



ENT-ORAL Laryngeal Scissors

Micro Laryngeal Scissors, W/ Flush Port

Catalog Number	Tip	Blade	Working Length (in.)
EL-4116	S/S	STR	9 3/4
EL-4117	S/S	CVD-LEFT	9 3/4
EL-4118	S/S	CVD-RIGHT	9 3/4
EL-4119	S/S	ANG-UP	9 3/4

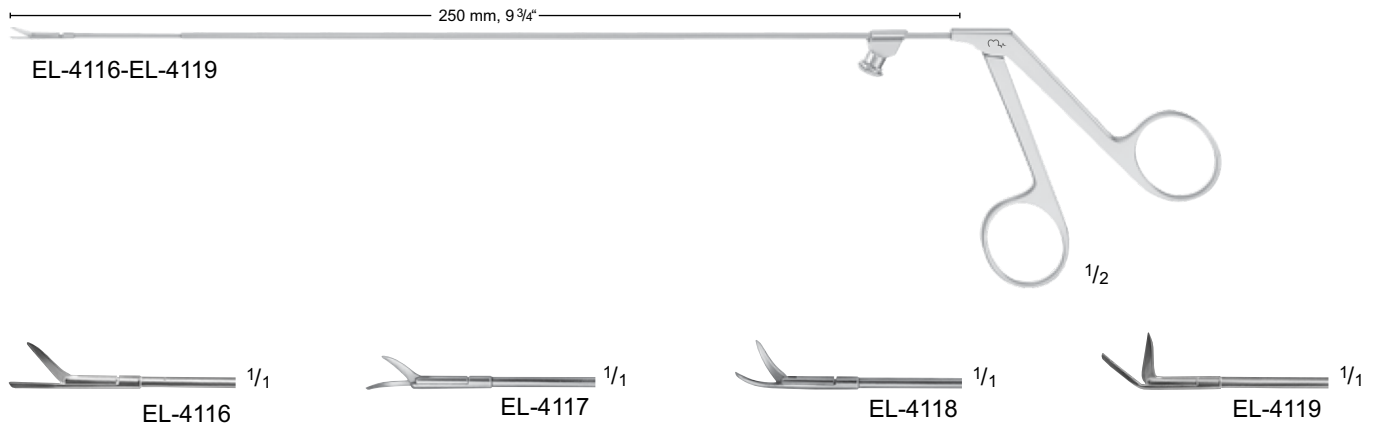

KLEINSASSER Micro Scissors

Catalog Number	Tip	Blade	Blade Size (mm)	Working Length (in.)
EL-4120	B/B	STR	4	14

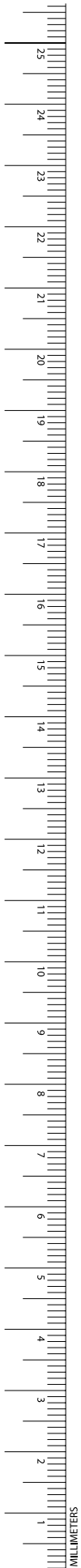
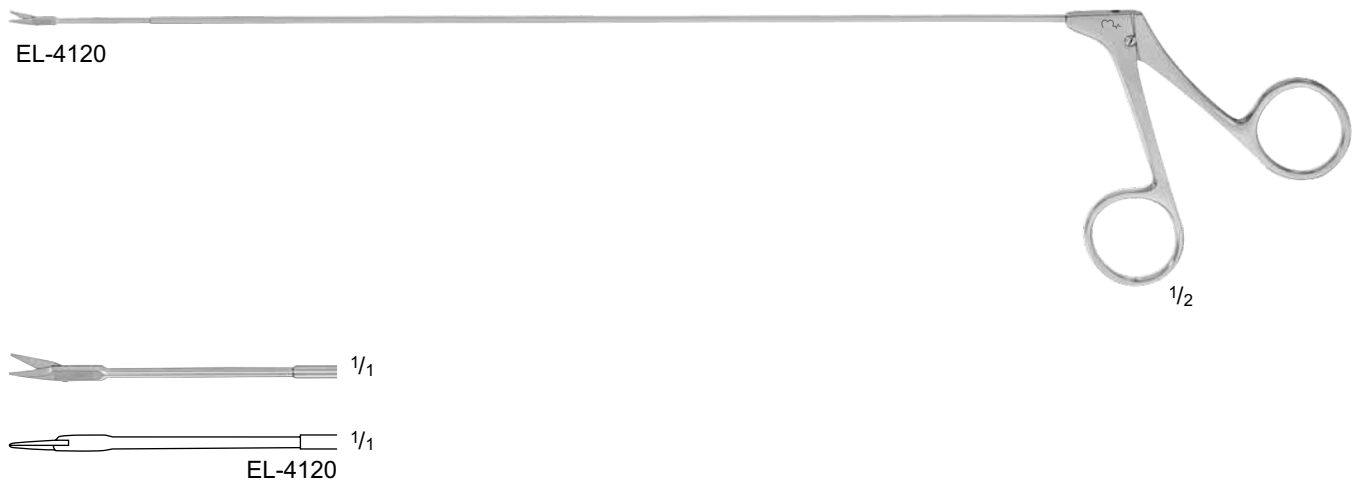



DINGMAN Wire Passing Needle

Catalog Number	Tip	Length (in.)
EL-4121	CVD	6 3/4



Tonsil Needle, 23 Gauge

Catalog Number	Tip	Tip Size (mm)	Length (in.)
EL-4122	STR	DIAM. 0.8	3
EL-4123	CVD	DIAM. 0.8	3



JACKSON Laryngeal Self-Closing Dressing Forceps

Catalog Number	Tip	Teeth	Length (in.)
EL-4124	SERR	1 x 2	9



ENT-ORAL
Forceps

Laryngeal Forceps, W/ Flush Port

Catalog Number	Jaw	Working Length (in.)
EL-4125	STR	9 3/4
EL-4126	CVD-LEFT	9 3/4
EL-4127	CVD-RIGHT	9 3/4

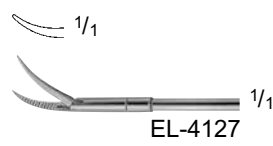
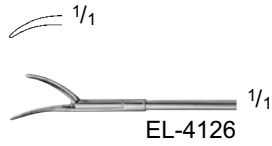
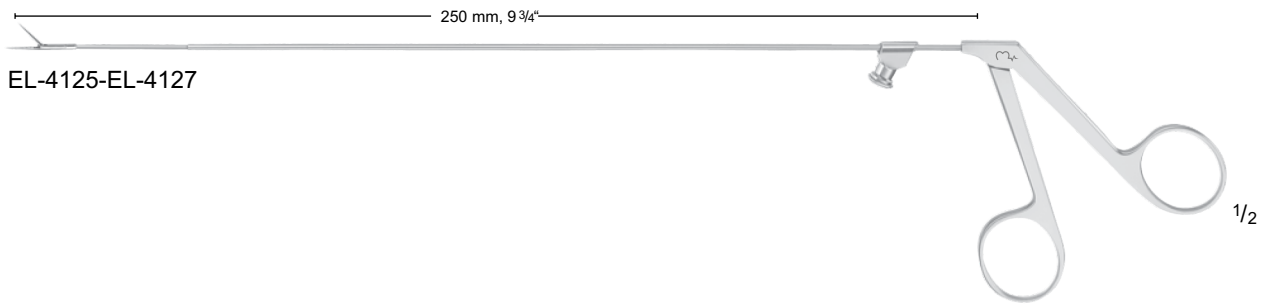

Micro Laryngeal Cup Forceps, W/ Flush Port

Catalog Number	Cup Size (mm)	Jaw	Working Length (in.)
EL-4128	2	STR	9 3/4
EL-4129	2	ANG-LEFT	9 3/4
EL-4130	2	ANG-RIGHT	9 3/4
EL-4131	2	ANG-UP	9 3/4

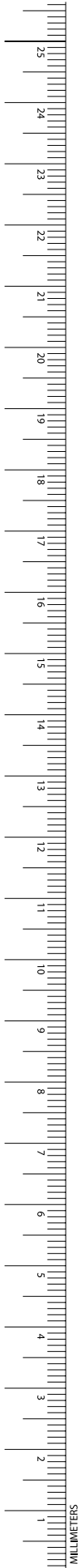
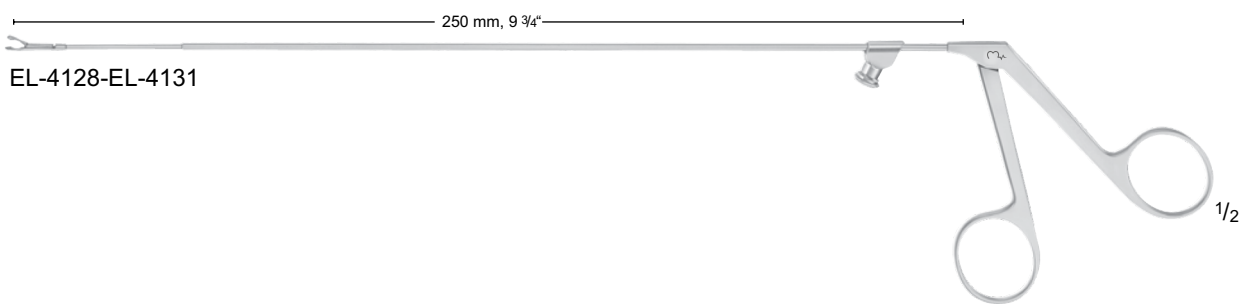

Alligator Grasping Forceps

Catalog Number	Tip	Tip Size (mm)	Working Length (in.)	Length (in.)
EL-4132	SERR	8.8 x 4	11	13 3/4



**ENT-ORAL
Forceps**

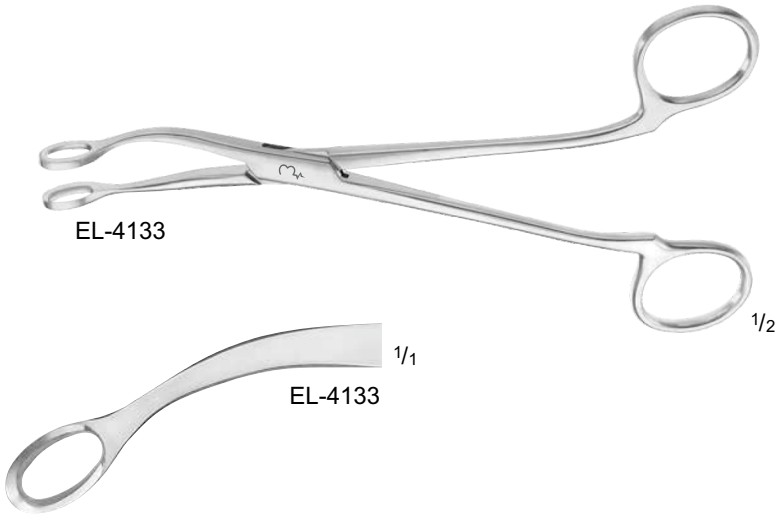

EL-4133

EL-4133



EL-4134-EL-4136



EL-4134

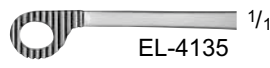

EL-4135



EL-4136

ST CLAIR Adenoid Forceps

Catalog Number	Length (in.)
EL-4133	7 1/2

MAGILL Forceps

Catalog Number	Size	Length (in.)
EL-4134	INFANT	6
EL-4135	PEDIATRIC	7 7/8
EL-4136	ADULT	9 3/4

SCHNIDT Tonsil Clamp

Catalog Number	Ring Handle	Jaw	Length (in.)
EL-4137	OPEN RING	STR	7 1/2
EL-4138	OPEN RING	SLIGHT-CVD	7 1/4
EL-4139	OPEN RING	CVD	7 1/4
EL-4140	CLOSED-RING	SLIGHT-CVD	7 1/4
EL-4141	CLOSED-RING	CVD	7 1/4



EL-4137

1/2



EL-4137

1/1

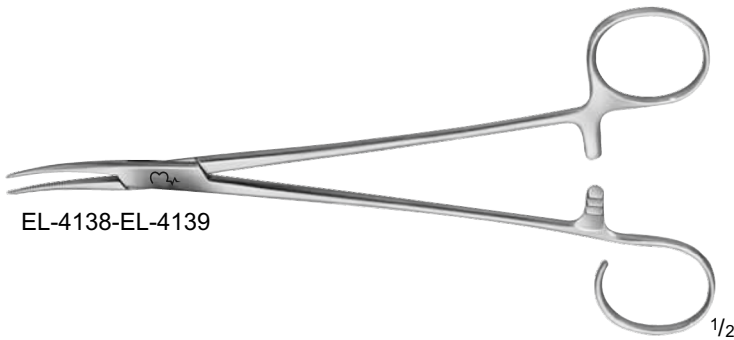

EL-4138-EL-4139

1/2



EL-4138

1/1



EL-4139

1/1

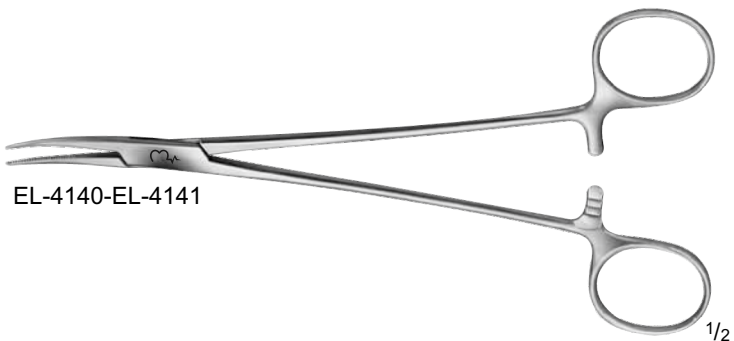

EL-4140-EL-4141

1/2



EL-4140

1/1



EL-4141

1/1



INCHES

**ENT-ORAL
Clamps**

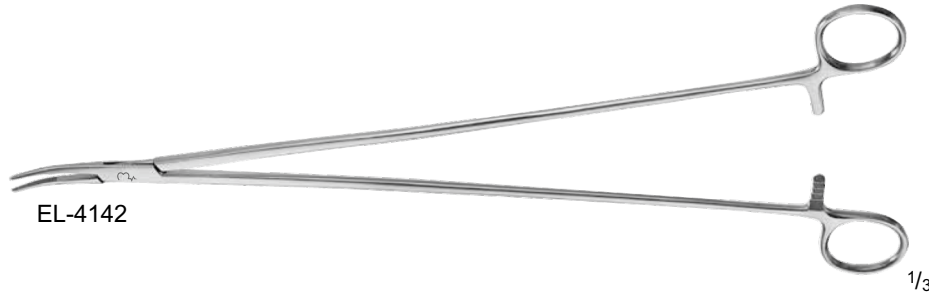

EL-4142

1/3



EL-4142

Tonsil Clamp, X-long

Catalog Number	Jaw	Length (in.)
EL-4142	CVD	14 1/2

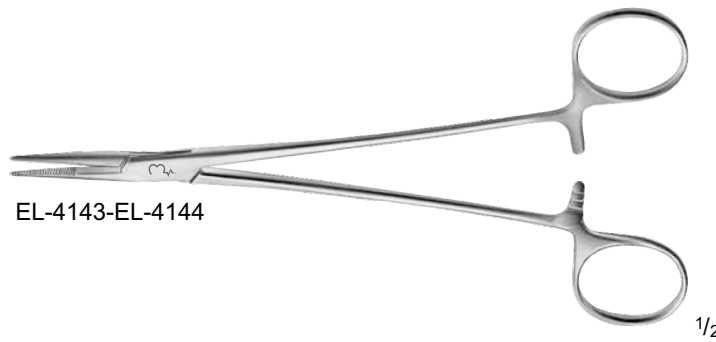

EL-4143-EL-4144

1/2



EL-4143



EL-4144

ADSON Tonsil Clamp, Delicate

Catalog Number	Jaw	Length (in.)
EL-4143	STR	7 1/4
EL-4144	CVD	7 1/4

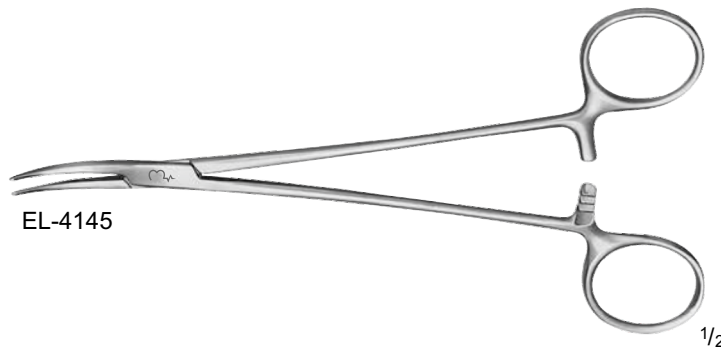

EL-4145

1/2



EL-4145

NISSEN Tonsil Clamp, Delicate

Catalog Number	Jaw	Length (in.)
EL-4145	CVD	7 1/4

NEGUS Tonsil Clamp

Catalog Number	Jaw	Length (in.)
EL-4146	HEAVY-CVD	7 1/2
EL-4147	U-CVD	7 1/2

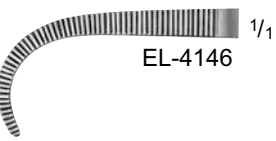
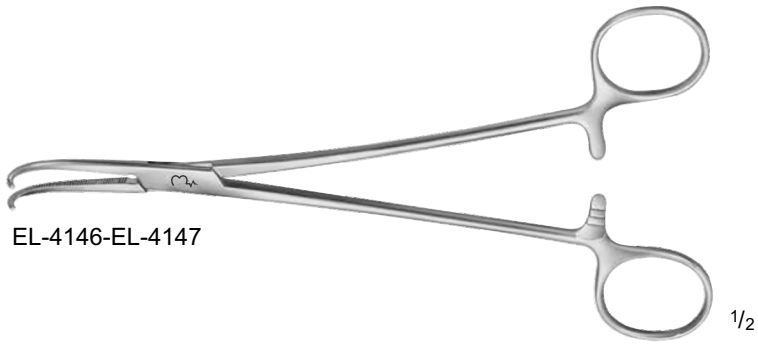

MCHENRY Tonsil Artery and Sponge Holding Clamp

Catalog Number	Jaw	Length (in.)
EL-4148	CVD	8

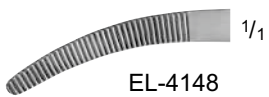
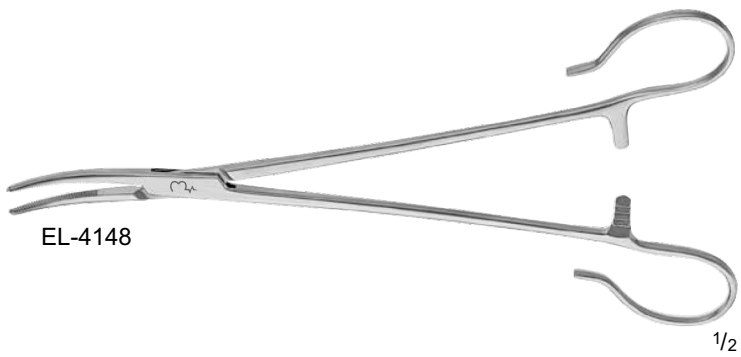

ENT-ORAL Clamps

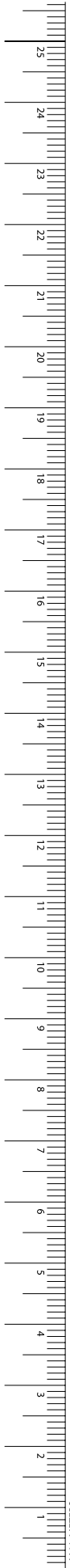

EL-4149

1/2

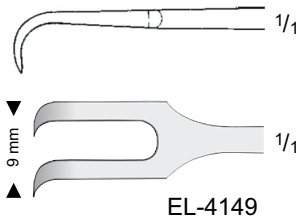

EL-4149

MUSEUX Tonsil Clamp

Catalog Number	Tip	Length (in.)
EL-4149	2 x 2	7 7/8

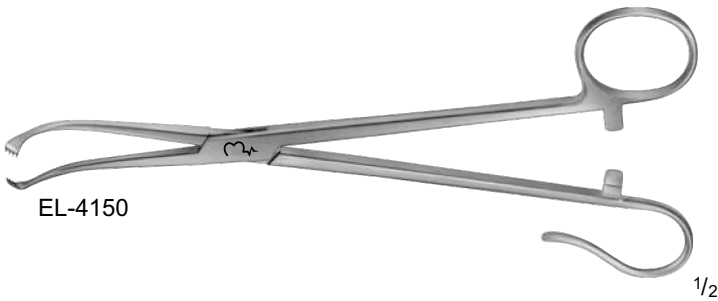

EL-4150

1/2

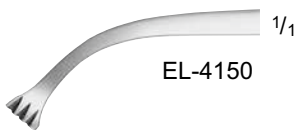

EL-4150

WHITE Tonsil Seizing Clamp

Catalog Number	Length (in.)
EL-4150	7
EL-4151	9 1/4

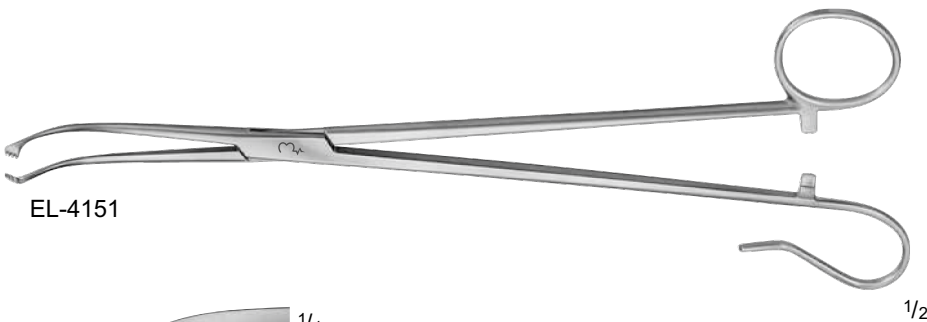

EL-4151

1/2



EL-4151



EL-4152

1/2



EL-4152

1/1



EL-4153

1/2



EL-4153

1/1



EL-4154

1/2



EL-4154

1/1

ALLIS-COAKLEY Tonsil Clamp

Catalog Number	Jaw	Length (in.)
EL-4152	STR	7 7/8
EL-4153	STRONG CVD	7 5/8

COLVER Tonsil Seizing Clamp

Catalog Number	Length (in.)
EL-4154	7 7/8

**ENT-ORAL
Clamps**

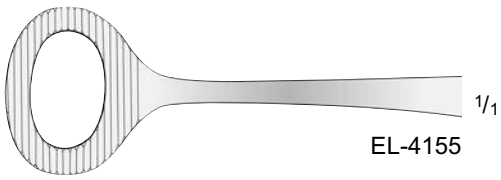
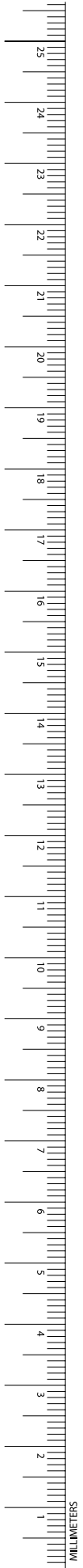

COLLIN Tongue Clamp

Catalog Number	Jaw	Length (in.)
EL-4155	OVAL	6 1/4

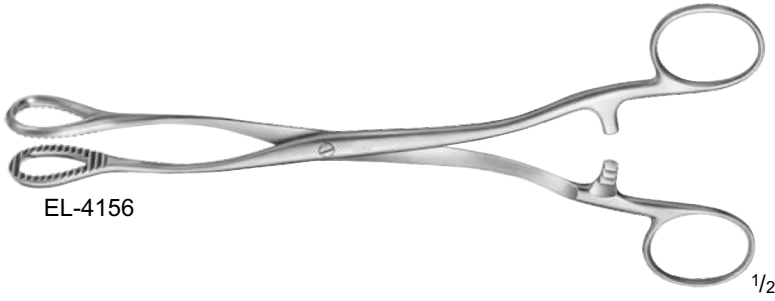

EL-4156

$\frac{1}{2}$

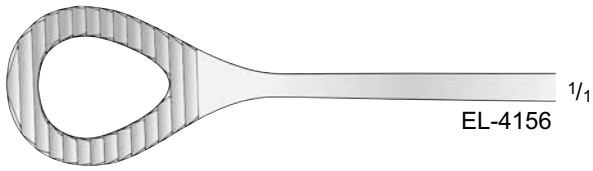

EL-4156

$\frac{1}{1}$



EL-4157

$\frac{1}{2}$

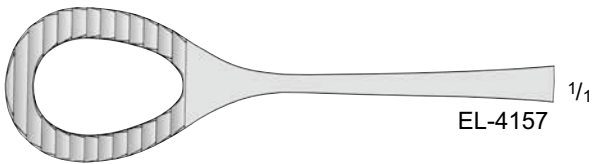

EL-4157

$\frac{1}{1}$

HEYWOOD-SMITH Tongue Clamp

Catalog Number	Tip	Length (in.)
EL-4156	SERR	7 $\frac{7}{8}$
EL-4157	SERR	8 $\frac{1}{4}$



ENT-ORAL

Tracheal Dilators/Hooks/Retractors

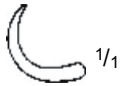
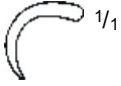
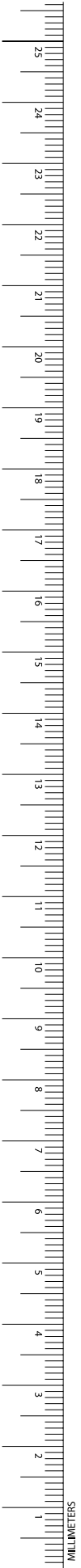

BOSE Tracheal Hook

Catalog Number	Tip	Length (in.)
EL-4158	CVD-LEFT	6 1/2
EL-4159	CVD-RIGHT	6 1/2

Tracheal Retractor

Catalog Number	Tip	Blade End	Length (in.)
EL-4160	SHARP	1 PRONG	7
EL-4161	BLUNT	1 PRONG	7
EL-4162	BLUNT	2 PRONGS	7

JACKSON Tracheal Retractor

Catalog Number	Length (in.)
EL-4163	7

ENT-ORAL

Tracheal Dilators/Hooks/Retractors



TROUSSEAU Tracheal Dilator

Catalog Number	Length (in.)
EL-4164	4 3/4



LABORDE Tracheal Dilator

Catalog Number	Length (in.)
EL-4165	5
EL-4166	5 1/4



**ENT-ORAL
Retractors**

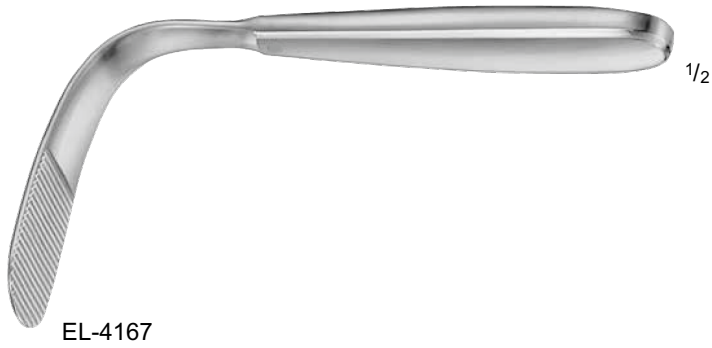
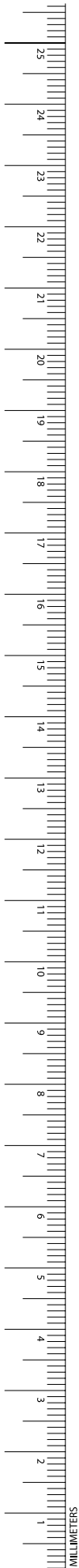

EL-4167



EL-4168-EL-4169

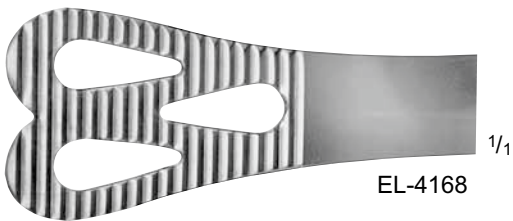

EL-4168

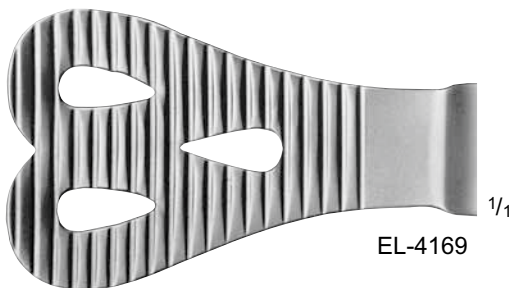

EL-4169

TOBOLD Tongue Depressor

Catalog Number	Length (in.)
EL-4167	6 1/4

WEDER Tongue Depressor

Catalog Number	Size	Length (in.)
EL-4168	SMALL	5
EL-4169	LARGE	5

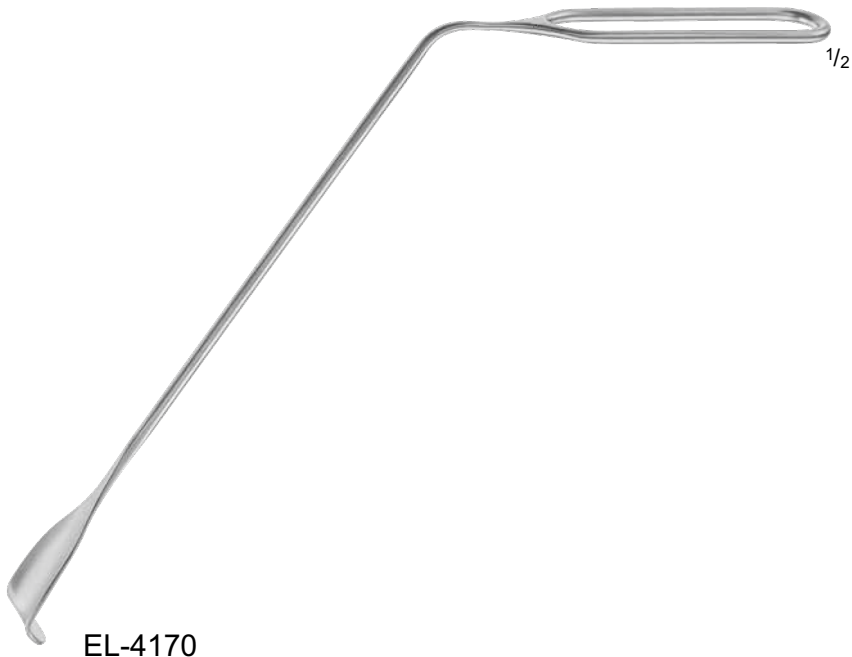

LOTHROP Uvula Retractor

Catalog Number	Blade Size (mm)	Length (in.)
EL-4170	17 x 20	9 5/8



GOODYEAR Uvula Retractor

Catalog Number	Blade Size (mm)	Length (in.)
EL-4171	15	7 3/8



LAHEY Goiter Retractor

Catalog Number	Blade Size (mm)	Length (in.)
EL-4172	24 x 8	7 7/8



ENT-ORAL
Retractors

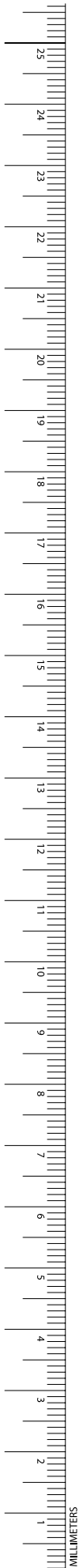

EL-4173-EL-4176



EL-4173

1/1



EL-4175

1/1

SEWALL Orbital Retractor

Catalog Number	Blade Size (mm)	Length (in.)
EL-4173	7 x 52	6 3/4
EL-4174	9 x 44	6 3/8
EL-4175	11 x 50	6 3/8
EL-4176	13 x 67	6 3/4



EL-4174

1/1



HURD Tonsil Dissector / Pillar Retractor

Catalog Number	Tip Size (mm)	Length (in.)
EL-4177	6	8 1/2
EL-4178	10	8 1/2

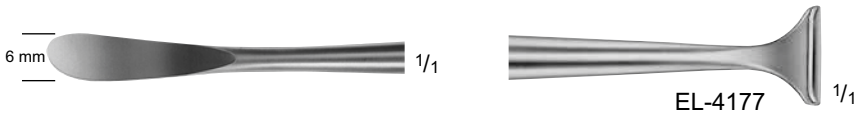

HENKE Tonsil Dissector

Catalog Number	Tip Size (mm)	Length (in.)
EL-4179	12	9 1/4

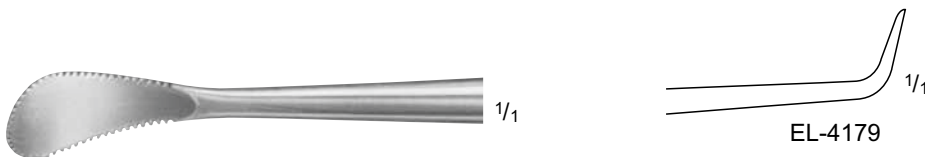

LOTHROP Tonsil Knife and Dissector

Catalog Number	Length (in.)
EL-4180	8 1/4



ENT-ORAL

Adenotomes/Tonsil Snares/Wires

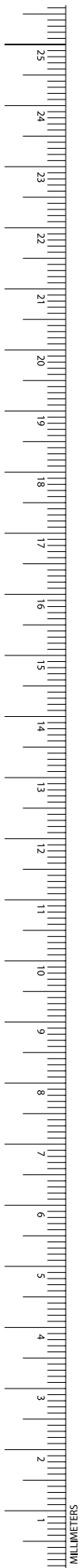

LA FORCE Adenotome

Catalog Number	Size (#)	Description	Length (in.)
EL-4181	1	-	9 1/4
EL-4182	2	-	9 1/4
EL-4183	3	-	9 1/4
EL-4184	-	SPARE BLADE	-
EL-4185	-	SPARE BLADE	-
EL-4186	-	SPARE BLADE	-

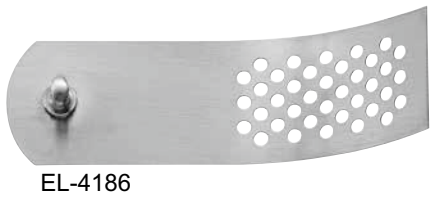
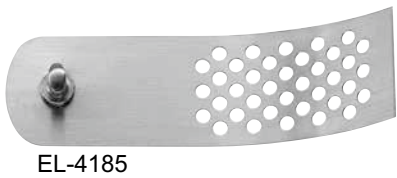

EVES Tonsil Snare W/ 25 Gauge Wire

Catalog Number	Description	Length (in.)
EL-4187	W/O RATCHET	9 3/4
EL-4188	W/ RATCHET	9 3/4



ENT-ORAL

Adenotomes/Tonsil Snares/Wires

LEWIS Tonsil Snare

Catalog Number	Description	Length (in.)
EL-4189	INCLUDES 12 #8 SNARE WIRES	10 1/4

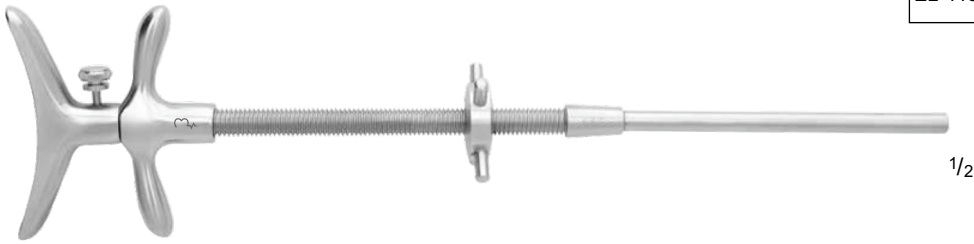

EL-4189

SAGE Tonsil Snare

Catalog Number	Description	Length (in.)
EL-4190	W/ SNARE WIRES	11
EL-4191	12 #6 SNARE WIRES	4

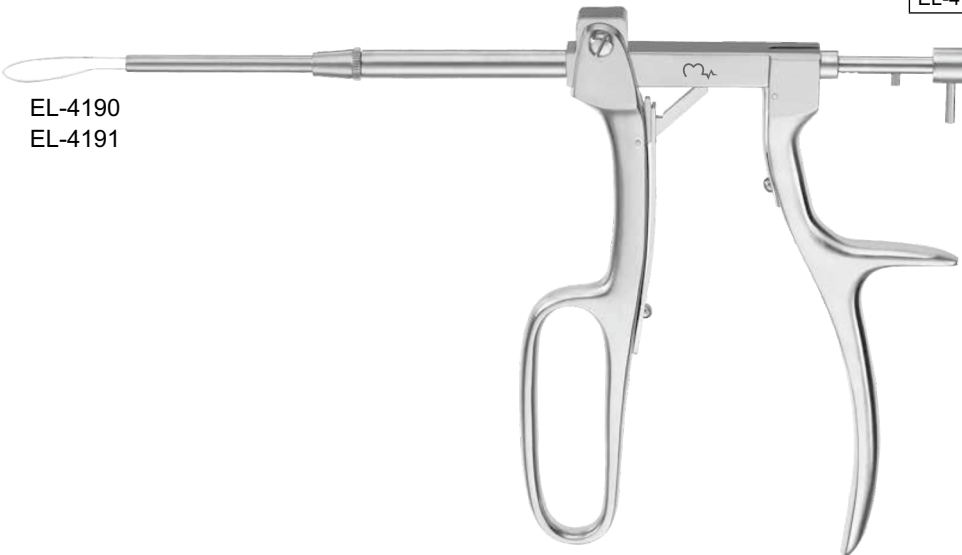

EL-4190
EL-4191

1/2



EL-4191

1/4



ENT-ORAL

Tonsil Snares/Wires/Adenotomes

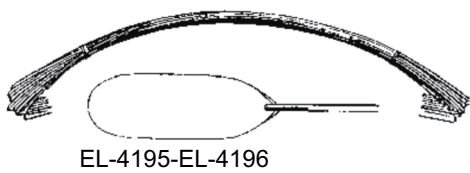
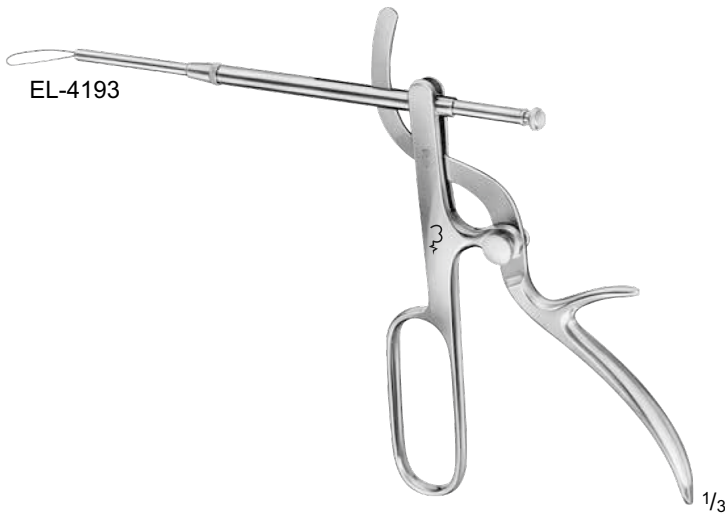
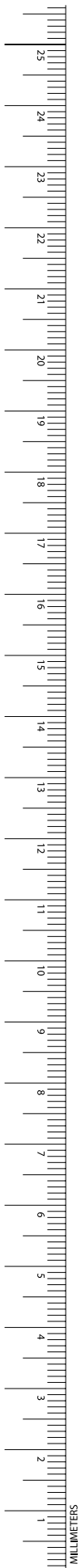

TYDING Tonsil Snare

Catalog Number	Description
EL-4192	-
EL-4193	TIP ONLY, STR

Tonsil Snare Wire

Catalog Number	Diameter (mm)	Size (#)	Sales Unit	Length (mm)
EL-4194	1.4	6	12/BOX	100
EL-4195	0.3	7	12/BOX	100
EL-4196	0.5	8	12/BOX	100

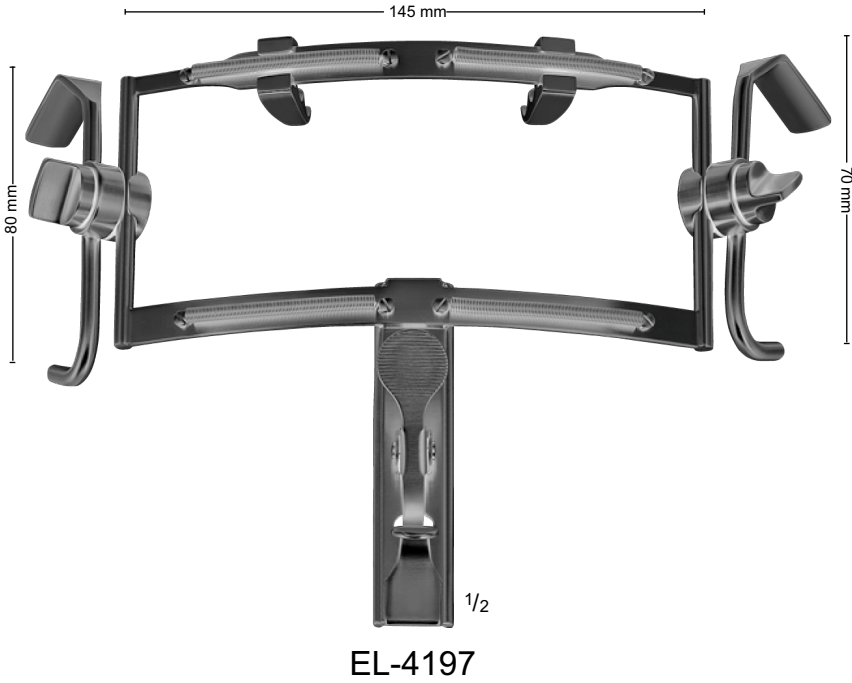

DINGMAN Mouth Gag

Catalog Number	Description
EL-4197	COMPLETE SET WITH 3 BLADES AND FRAME



MOLT Mouth Gag, Pediatric

Catalog Number	Description	Length (in.)	Length (m)
EL-4198	-	4	-
EL-4199	SPARE SILICONE TUBE ONLY, LATEX-FREE	-	1



DOYEN-COLLIN Mouth Gag

Catalog Number	Description	Length (in.)	Length (m)
EL-4200	-	4 3/4	-
EL-4201	SPARE SILICONE TUBE ONLY, LATEX-FREE	-	1



ENT-ORAL Mouth Gags

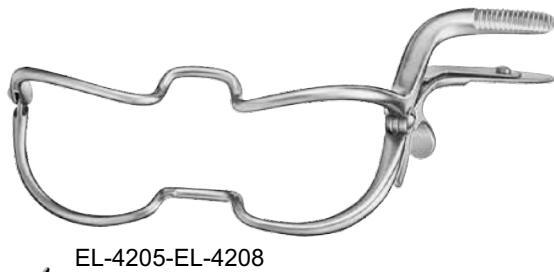

DOYEN-JANSEN Mouth Gag

Catalog Number	Description	Length (in.)	Length (m)
EL-4202	-	5 1/2	-
EL-4203	SPARE SILICONE TUBE ONLY, LATEX-FREE	-	1

DENHARDT Mouth Gag

Catalog Number	Length (in.)
EL-4204	5

WHITEHEAD-JENNINGS Mouth Gag

Catalog Number	Length (in.)
EL-4205	3 1/2
EL-4206	4 1/4
EL-4207	5 1/8
EL-4208	6

Teeth Protector, Latex-Free Rubber

Catalog Number	Size
EL-4209	ADOLESCENT AND ADULT





EL-4212



EL-4213



EL-4214



EL-4215



EL-4216



EL-4217



EL-4218

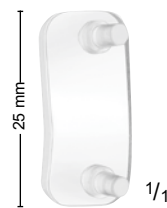

EL-4219

DAVIS Mouth Gag

Catalog Number	Blade Size (mm)	Size (#)	Description	Length (in.)
EL-4210	-	-	COMPLETE SET, RIGHT	-
EL-4211	-	-	COMPLETE SET, LEFT	-
EL-4212	-	-	RIGHT FRAME ONLY	6
EL-4213	20 x 34	1	BLADE	5 1/4
EL-4214	23 x 64	2	BLADE	5 1/4
EL-4215	25 x 79	3	BLADE	5 1/4
EL-4216	25 x 85	3 1/2	BLADE	5 1/8
EL-4217	25 x 95	4	BLADE	5 1/8
EL-4218	25 x 106	5	BLADE	5 1/8
EL-4219	SILICONE INSERT			



ENT-ORAL
Mouth Gags

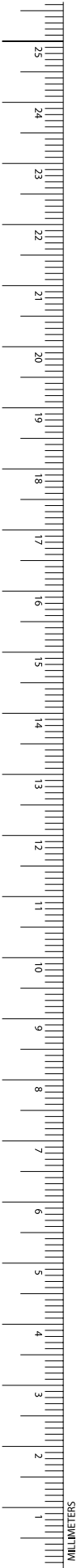

EL-4220



EL-4221

DAVIS Mouth Gag W/ Tube

Catalog Number	Blade Size (mm)	Size (#)
EL-4220	24 x 80	3
EL-4221	25 x 90	3

DAVIS-BOYLE Mouth Gag

Catalog Number	Blade Size (mm)	Size	Description	Length (in.)
EL-4222	-	CHILD	FRAME ONLY	5 1/4
EL-4223	-	TEEN	FRAME ONLY	5 3/4
EL-4224	-	ADULT	FRAME ONLY	6 3/4
EL-4225	25 x 62	-	BLADE	-
EL-4226	25 x 75	-	BLADE	-
EL-4227	25 x 92	-	BLADE	-
EL-4228	25 x 108	-	BLADE	-
EL-4229	SILICONE INSERT			-

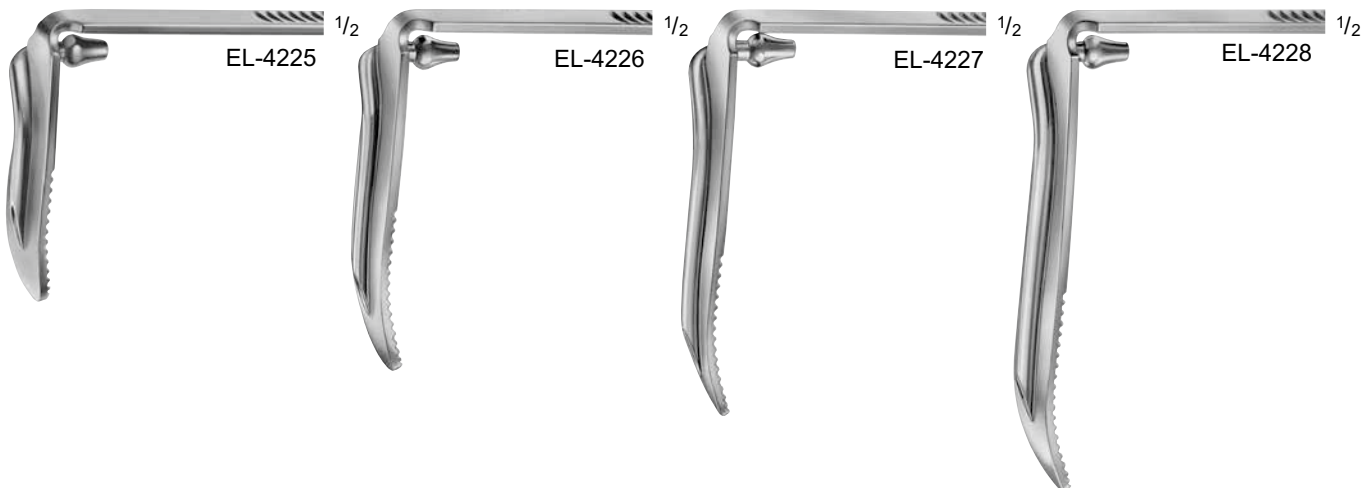
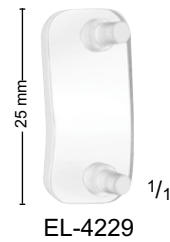
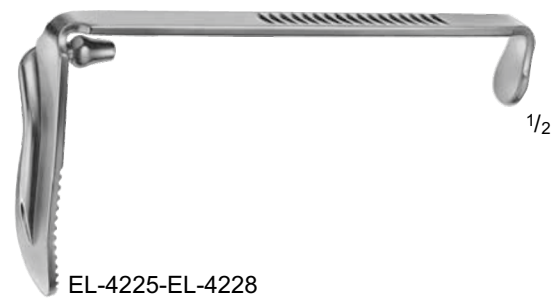

ENT-ORAL Mouth Gags



EL-4230



1/1



1/1

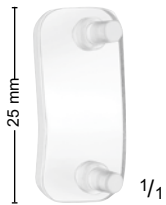

EL-4231



EL-4232

1/2

DAVIS-MEYER Tongue Depressor Frame

Catalog Number	Description
EL-4230	FRAME, COMPLETE
EL-4231	SILICONE INSERT
EL-4232	PALATE BLADE

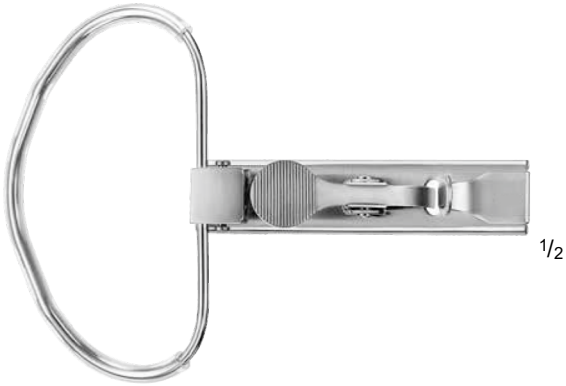

EL-4233



EL-4234-EL-4235



EL-4237



EL-4242-EL-4247



EL-4239-EL-4241



EL-4248-EL-4249

MCIVOR Mouth Gag

Catalog Number	Blade Size (mm)	Size (#)	Description	Length (in.)
EL-4233	-	-	COMPLETE WITH FRAME AND 3 TONGUE BLADES	-
EL-4234	22 x 69	1	BLADE	5 3/8
EL-4235	24 x 90	2	BLADE	5 3/8
EL-4236	25 x 100	3	BLADE	5 3/8
EL-4237	-	-	FRAME F/ TONGUE DEPRESSOR	5 1/2
EL-4238	-	-	REPLACEMENT TUBE F/ OM104R	-
EL-4239	25 x 55	-	BLADE	-
EL-4240	25 x 62	-	BLADE	-
EL-4241	25 x 75	-	BLADE	-
EL-4242	57 x 23	2	BLADE, RIGHT	-
EL-4243	72 x 27	3	BLADE, RIGHT	-
EL-4244	88 x 33	4		-
EL-4245	57 x 23	2	BLADE, LEFT	-
EL-4246	72 x 27	3	BLADE, LEFT	-
EL-4247	88 x 33	4	BLADE, LEFT	-
EL-4248	97 x 36	5	BLADE, LEFT	-
EL-4249	97 x 36	5	BLADE, RIGHT	-



ENT-ORAL

Mouth Gags

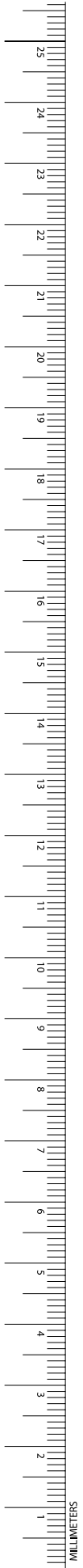

EL-4250-EL-4257



EL-4250



EL-4251



EL-4252



EL-4253



EL-4254



EL-4255



EL-4256



EL-4257

RUSSEL-DAVIS Tongue Blade

Catalog Number	Blade Size (mm)
EL-4250	29 x 67
EL-4251	33 x 75
EL-4252	38 x 85
EL-4253	40 x 92
EL-4254	46 x 100
EL-4255	18 x 57
EL-4256	22 x 67
EL-4257	25 x 75

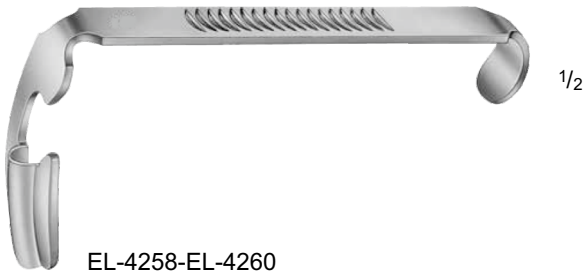

GAST Tongue Blade

Catalog Number	Blade Size (mm)
EL-4258	28 x 64
EL-4259	34 x 74
EL-4260	38 x 87

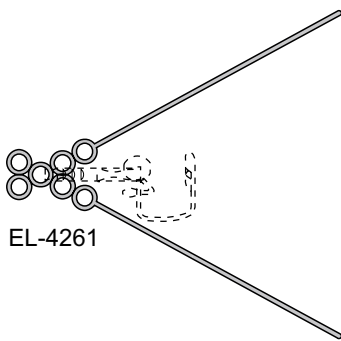

DRAFFIN Chest Support, W/ 4 Height Rings

Catalog Number	Length (in.)
EL-4261	18 7/8

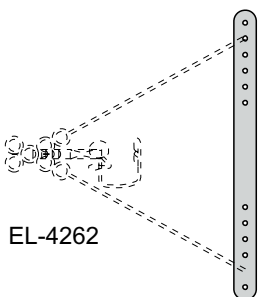

MAGAURAN Plate, F/ Holding OM186R

Catalog Number	Length (in.)
EL-4262	16



ENT-ORAL
Tonsil Knives

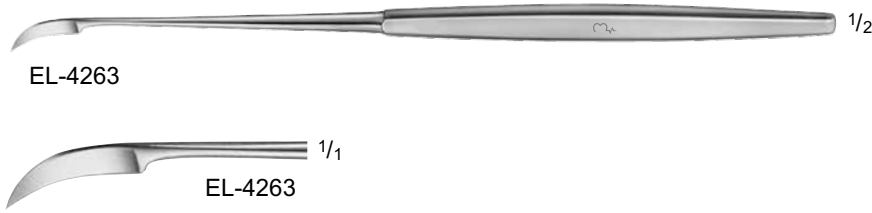
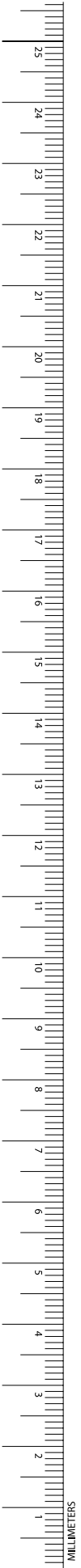

ABRAHAM Tonsil Knife

Catalog Number	Length (in.)
EL-4263	8 $3/4$

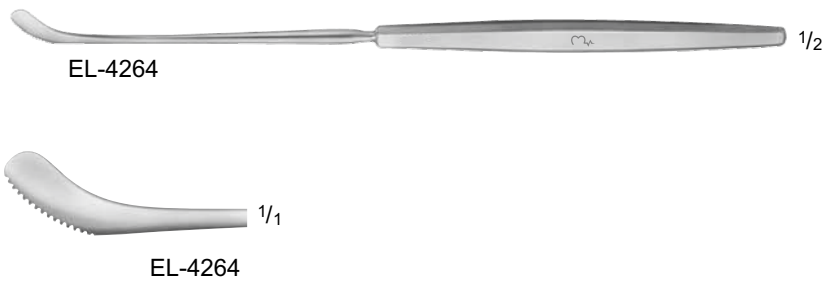

FISHER Tonsil Knife

Catalog Number	Length (in.)
EL-4264	8

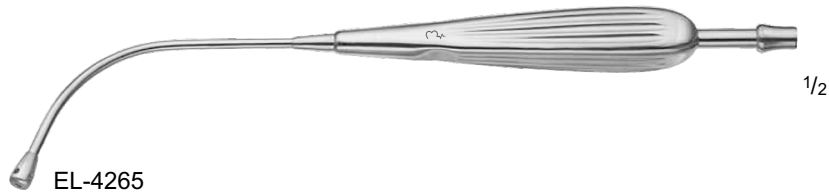

ANDREWS Pynchon Suction Tube

Catalog Number	Description	Length (in.)
EL-4265	-	9
EL-4266	TIP ONLY	-



EL-4266



Suction Tube, W/ Finger Cut-OFF

Catalog Number	Tip Size (mm)	Working Length (in.)
EL-4267	2.0	9 3/4
EL-4268	2.5	9 3/4
EL-4269	3.0	9 3/4



JACKSON Velvet Eye Aspirating Tube

Catalog Number	Diameter (mm)	Length (in.)
EL-4270	4.0	10
EL-4271	4.0	16 3/8
EL-4272	4.0	22
EL-4273	4.0	18 1/8



ENT-ORAL Curettes

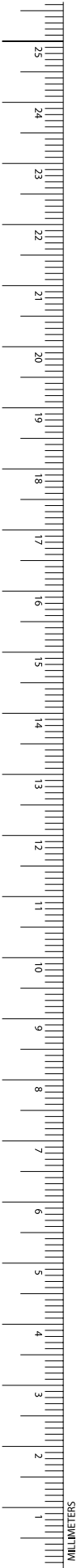

EL-4274-EL-4277

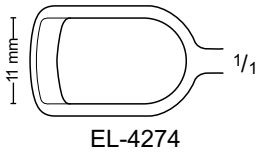

EL-4274

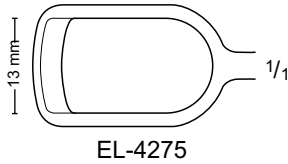

EL-4275

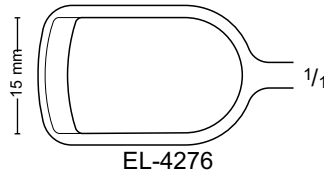

EL-4276

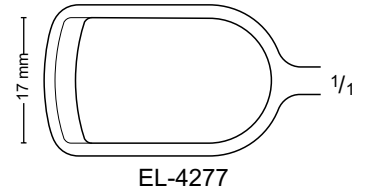

EL-4277



EL-4278-EL-4289

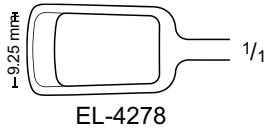

EL-4278

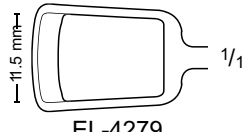

EL-4279

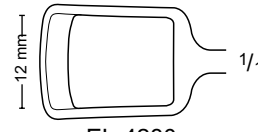

EL-4280

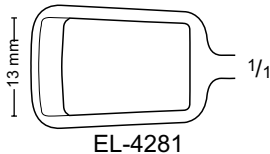

EL-4281

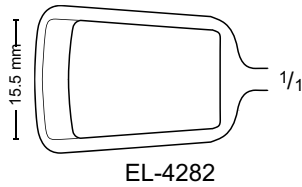

EL-4282

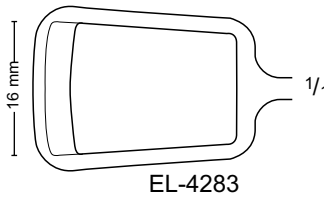

EL-4283



EL-4284-EL-4289



EL-4284

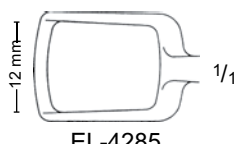

EL-4285



EL-4286

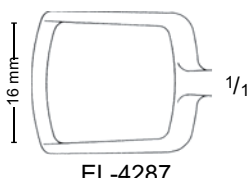

EL-4287

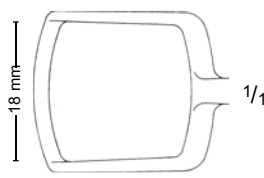

EL-4288

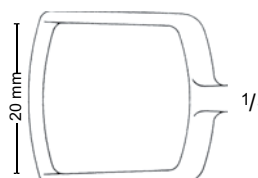

EL-4289

BARNHILL Adenoid Curette

Catalog Number	Tip Size (mm)	Length (in.)
EL-4274	11	7 7/8
EL-4275	13	7 7/8
EL-4276	15	7 7/8
EL-4277	17	7 7/8

BECKMANN Adenoid Curette

Catalog Number	Tip Size (mm)	Length (in.)
EL-4278	9.25	7 7/8
EL-4279	11.5	7 7/8
EL-4280	12	7 7/8
EL-4281	13	7 7/8
EL-4282	15.5	7 7/8
EL-4283	16	7 7/8
EL-4284	10	8 3/4
EL-4285	12	8 3/4
EL-4286	14	8 3/4
EL-4287	16	8 3/4
EL-4288	18	8 3/4
EL-4289	20	8 3/4



EL-4290-EL-4292

JONES Adenoid Curette

Catalog Number	Tip Size (mm)	Size (#)	Size	Length (in.)
EL-4290	4	1	INFANT	8 3/4
EL-4291	6	2	CHILD	8 7/8
EL-4292	8	3	ADULT	8 7/8



EL-4290



EL-4291



EL-4292



EL-4293

MIDDLETON Adenoid Curette

Catalog Number	Tip Size (mm)	Length (in.)
EL-4293	7	8 7/8



EL-4293



EL-4294-EL-4298

NEGUS Adenoid Curette

Catalog Number	Tip Size (mm)	Length (in.)
EL-4294	10	7 7/8
EL-4295	12.25	7 7/8
EL-4296	14	7 7/8
EL-4297	16.5	7 7/8
EL-4298	18	7 7/8



EL-4294

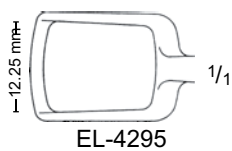

EL-4295

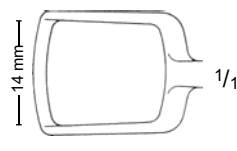

EL-4296

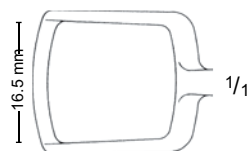

EL-4297

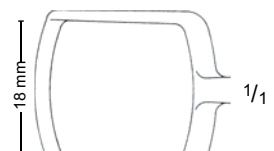

EL-4298



ENT-ORAL Curettes

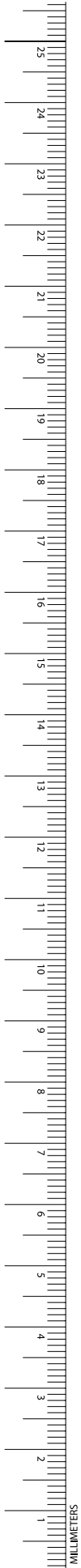

EL-4299-EL-4300

1/2

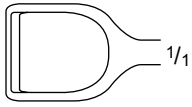

EL-4299

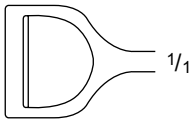

EL-4300



EL-4301-EL-4302

1/2

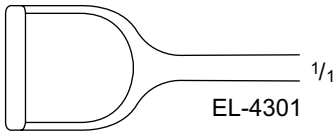

EL-4301

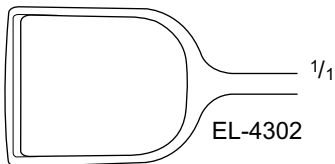

EL-4302



EL-4303

1/2



EL-4303

STUBBS Adenoid Curette

Catalog Number	Tip Size (mm)	Size (#)	Length (in.)
EL-4299	11	0	8 1/2
EL-4300	14	1	8 1/2
EL-4301	16	2	8 1/2
EL-4302	18	3	8 1/2

VOGEL Adenoid Curette, Infant

Catalog Number	Tip Size (mm)	Length (in.)
EL-4303	7	8 1/2

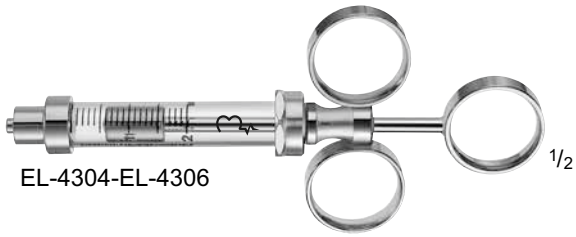

Syringe

Catalog Number	Diameter (mm)	Volume (cc)	Length (in.)
EL-4304	11	3	5 1/2
EL-4305	14	5	5 1/2
EL-4306	17	10	5 1/2



ENT-ORAL

Laryngeal Mirrors

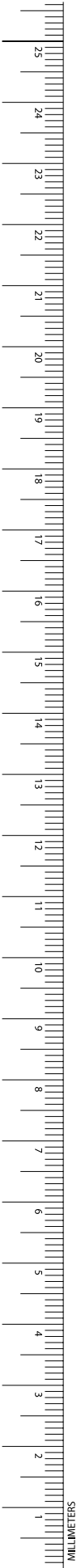

EL-4307-EL-4319

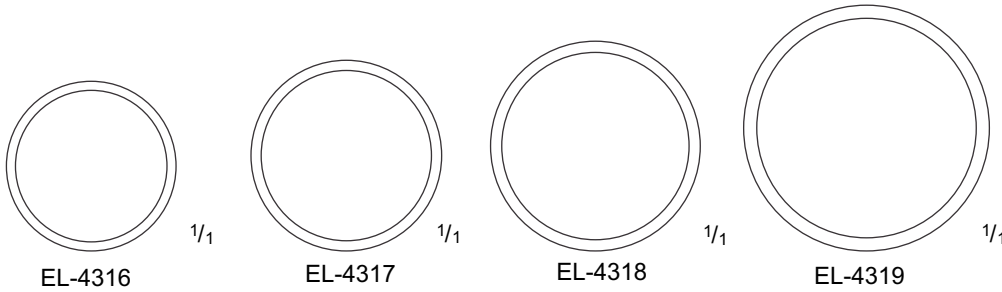
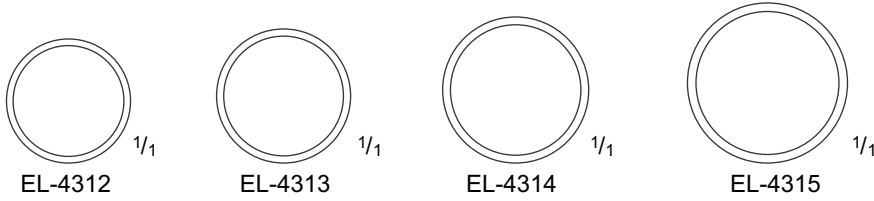

EL-4320-EL-4332



EL-4333

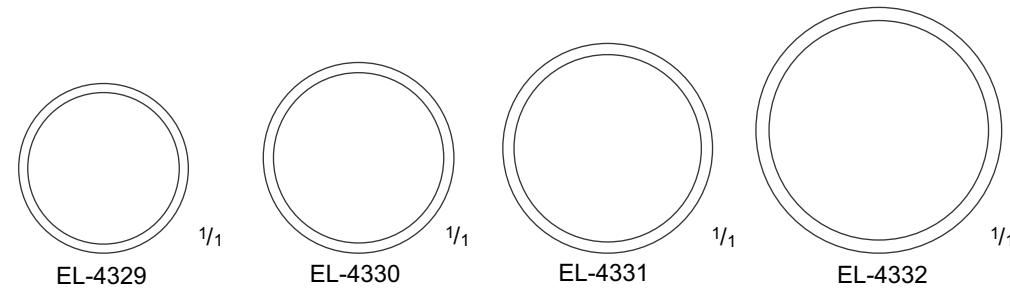
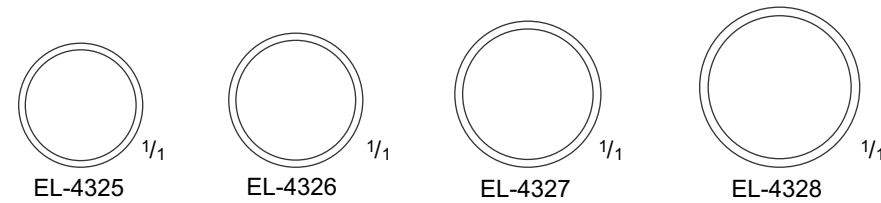
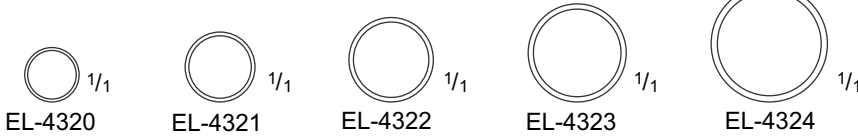

Laryngeal Mirror, Rigid, W/ Hex Handle

Catalog Number	Size (#)	Diameter (mm)	Length (in.)
EL-4307	000	6.0	7
EL-4308	00	8.0	7
EL-4309	0	10.0	7
EL-4310	1	12.0	7
EL-4311	2	14.0	7
EL-4312	3	16.0	7
EL-4313	4	18.0	7
EL-4314	5	20.0	7
EL-4315	6	22.0	7
EL-4316	7	24.0	7
EL-4317	8	26.0	7
EL-4318	9	28.0	7
EL-4319	10	30.0	7

Laryngeal Mirror, Rigid, F/ Handle AC481R

Catalog Number	Size (#)	Diameter (mm)	Length (in.)
EL-4320	000	6.0	4 3/4
EL-4321	00	8.0	4 3/4
EL-4322	0	10.0	4 3/4
EL-4323	1	12.0	4 3/4
EL-4324	2	15.0	4 3/4
EL-4325	3	16.0	4 3/4
EL-4326	4	18.0	4 3/4
EL-4327	5	20.0	4 3/4
EL-4328	6	22.0	4 3/4
EL-4329	7	24.0	4 3/4
EL-4330	8	26.0	4 3/4
EL-4331	9	28.0	4 3/4
EL-4332	10	30.0	4 3/4
EL-4333	-	HANDLE	4 1/4



Amalgam Carrier, Double Ended

Catalog Number	Size	Length (in.)
EL-4334	MEDIUM / LARGE	7 7/8





All rights reserved. Technical alterations are possible. This leaflet may be used for no other purposes than offering, buying and selling of our products. No part may be copied or reproduced in any form. In the case of misuse, we retain the rights to recall our catalogues and price lists and to take legal actions.